

# DISPOSABLE PRODUCTS

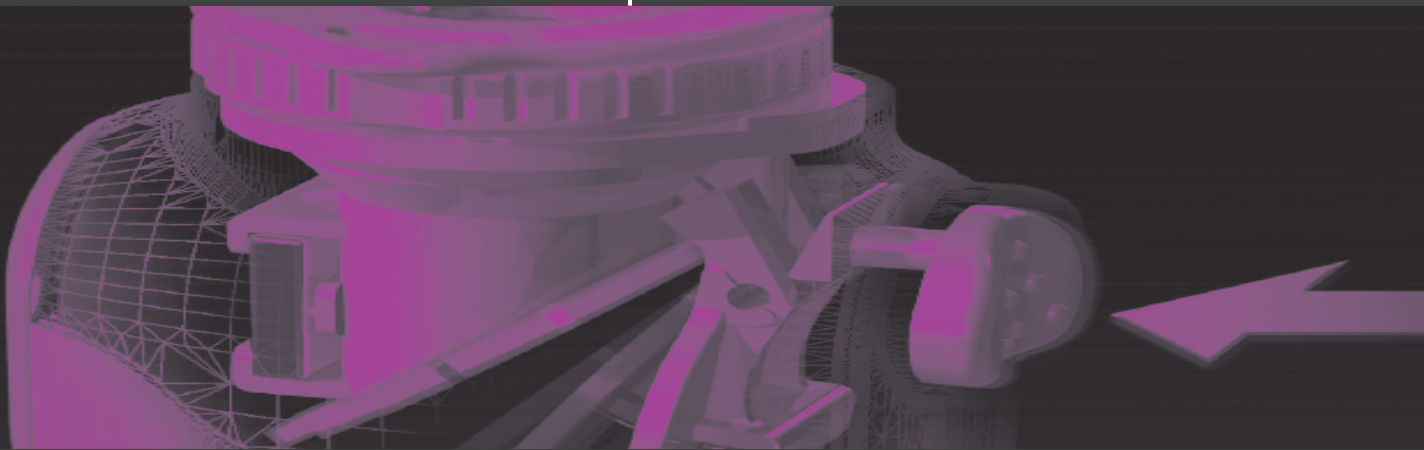

[www.mgb-berlin.de](http://www.mgb-berlin.de)

**MGB**

# CONTENT

**LapBags, Verres Needles, Clips, Drape and Filter**

*Page 3*

**Laport, Disposable Trocar System**

*Page 4-5*

**Disposable Laparoscopic Instruments**

*Page 6-8*

**Disposable Electrosurgical Pencil**

*Page 8*

**Dispoable Overmould Electrode**

*Page 9*

**Skin Stapler**

*Page 10*

**Ground Pad and Cables**

*Page 11-12*

# DISPOSABLES

## LAPBAGS, VERRES NEEDLE AND CLIPS

### Products

### Order-No.

### Description



420-01010  
(Size XL/190 x 210 mm)

420-01020  
(Size L/160 x 180 mm)

420-01030  
(Size M/120 x 135 mm)

#### LapBag

- MGB's LapBag is a highend retrievable system
- Automatically opened by preloaded spring
- Transparent and ultimate-strength bag-materiel
- For use with a minimum Ø 10 mm trocar sleeve
- Easy handling

- Sterile
- 10 pcs./box

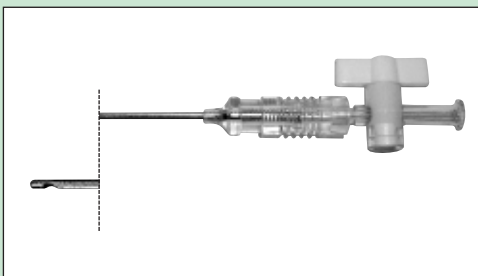

420-02010

420-02020

#### Verres Needle

- Luer stopcock
- Working length: 120 mm
- Working length: 150 mm

- Sterile
- 25 pcs./box



420-01200

#### TV Camera Drape

- 13 x 250 cm

- Sterile
- 100 pcs./box



429-70379

#### SLS-Titan Clips

- 13 x 250 cm

- Sterile
- 20 Cartridges of 6 medium/large Clips

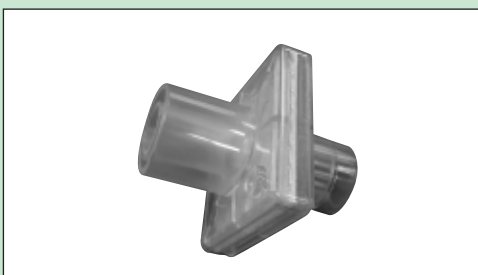

675-11200

#### Filter

- For insufflator
- Conus 15 mm

- 50 pcs./box

# DISPOSABLES

## Laport® DISPOSABLE TROCAR SYSTEM



### New Design

- Transparent sleeve and transparent trocar housing
- Magnetic flap-valve
- Flap-valve activated by the instrument or manually by pressing a button
- Ergonomic trocar-housing with better weight-balance
- Fixed and 360° rotatable reducer for sleeve-diameter 10mm/11mm, 12 mm
- New and extremely fast responding safety shield-system
- New designed dilating obturator
- In combination with the approved benefits of the former version (like threaded integrated sleeve, availability in set's etc.), you will be able to compete successfully in the "premium market" of disposable access instrumentation

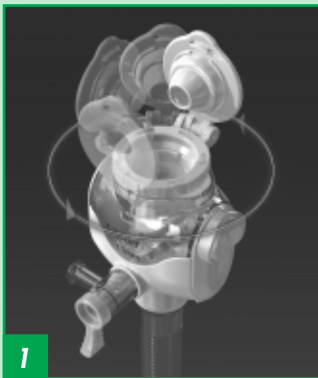

1



2



3

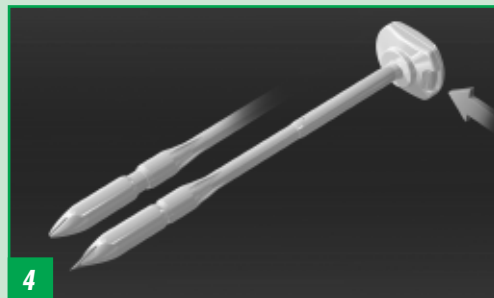

4

### 1 Rotating Reducer Cap:

It has a reducer cap, which can be rotated 360°, for comfortable performance of surgical procedures.

### 2 One Touch Valve Control:

A valve, which is driven by a button, allows sealing of the system. Its activation is useful for intra-abdominal gauze or specimen retrieval. It can be activated with a single hand. A stopcock for gas insufflation is included.

### 3 No Fear for reducer Cap Loss:

The reducer cap is connected to the main body of trocar through a hinge, thus risk of reducer cap loss or contamination is eliminated.

### 4 Simple Blade Activation System:

The obturator has a safety button which activates a retractile internal cutting knife. It is only activated during trocar insertion maneuver.

## DISPOSABLE TROCAR SYSTEM

### Products

### Order-No.

### Description

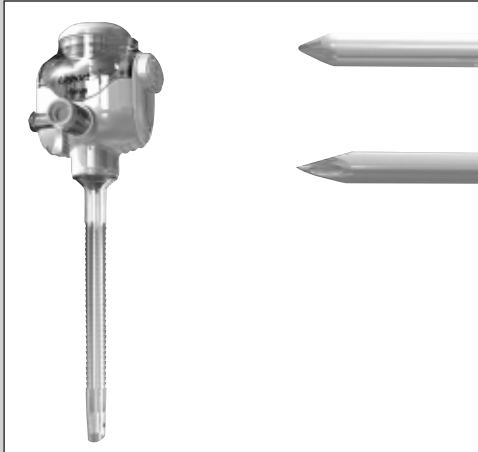

**420-04105 (100 mm)**  
**420-04105/75 (75 mm)**

#### Laport Disposable Trocar-Set

- Trocar sleeve and safety shielded trocar

**420-04205 (100 mm)**  
**420-04205/75 (75 mm)**

- Trocar sleeve and dilating trocar

**420-04305 (100 mm)**  
**420-04305/75 (75 mm)**

- Disposable trocar sleeve

### Ø 5 mm

- 10 pcs./box
- Working length: 100 mm/75 mm

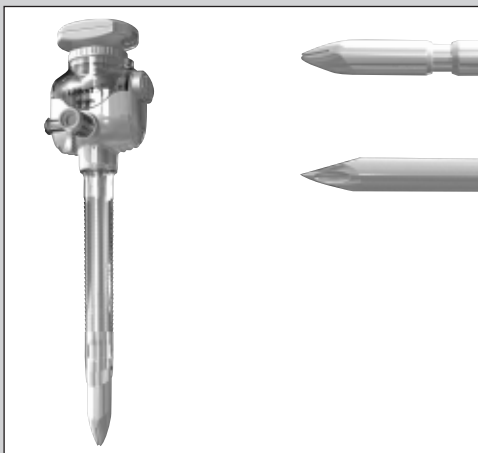

**420-04111**

#### Laport Disposable Trocar-Set

- Trocar sleeve and safety shielded trocar

**420-04211**

- Trocar sleeve and dilating trocar

**420-04311**

- Disposable trocar sleeve

### Ø 10/11 mm

- 10 pcs./box
- incl. reducer for Ø 5 mm instruments
- Working length: 100 mm

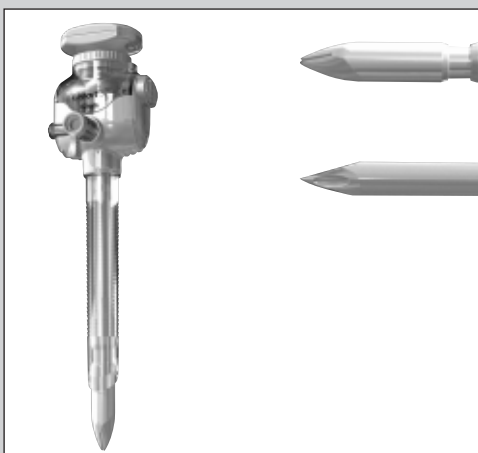

**420-04112**

#### Laport Disposable Trocar-Set

- Trocar sleeve and safety shielded trocar

**420-04212**

- Trocar sleeve and dilating trocar

**420-04312**

- Disposable trocar sleeve

### Ø 12 mm

- 10 pcs./box
- incl. reducer for Ø 5 mm instruments
- Working length: 100 mm

# DISPOSABLES

## DISPOSABLE LAPAROSCOPIC INSTRUMENTS

### Products

### Order-No.

### Description



L 09 S-330/2

#### Straight Scissor

- Double action
- Working length: 330 mm

■ 10 pcs./box



L 09 C-330/2

#### Curved Scissor

- Double action
- Working length: 330 mm

■ 10 pcs./box

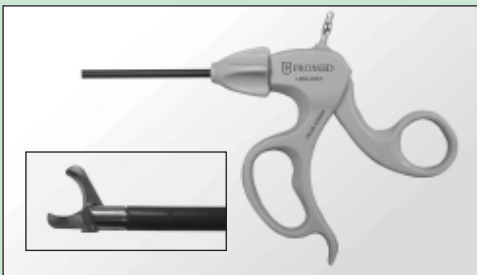

L 09 G-330/1

#### Hook Scissor

- Single action
- Working length: 330 mm

■ 10 pcs./box

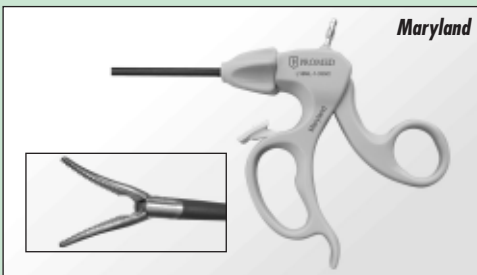

L 18 ML-1-330/2

#### Dissecting Forceps

- Double action
- With ratchet
- Working length: 330 mm

■ 10 pcs./box



L 18 ML-0-330/2

#### Dissecting Forceps

- Double action
- Without ratchet
- Working length: 330 mm

■ 10 pcs./box

# DISPOSABLES

## DISPOSABLE LAPAROSCOPIC INSTRUMENTS

### Products

### Order-No.

### Description



L 05-330/2

#### Biopsy Forceps

- Double action
- Working length: 330 mm

■ 10 pcs./box

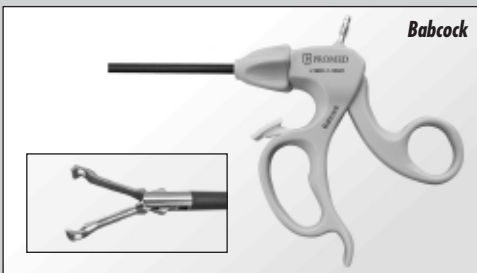

Babcock

L 19 BC-1-330/2

#### Grasping Forceps

- Double action
- With ratchet
- Working length: 330 mm

■ 10 pcs./box

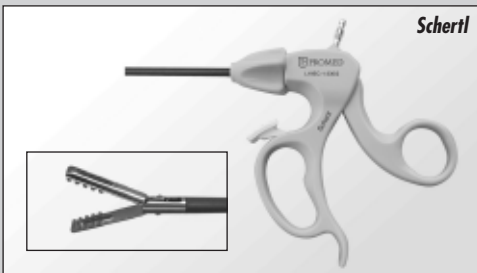

Schertl

L 19 EC-1-330/2

#### Grasping Forceps

- Double action
- With ratchet
- Working length: 330 mm

■ 10 pcs./box

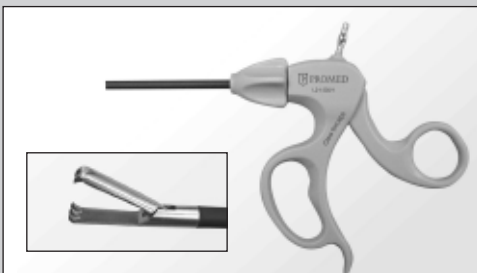

L 21-330/1

#### Claw Forceps

- Double action
- Working length: 330 mm

■ 10 pcs./box

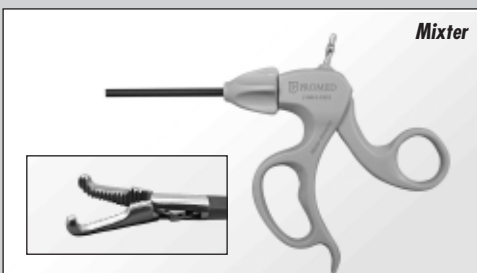

Mixer

L 18 M-0-330/2

#### Dissecting Forceps

- Double action
- Working length: 330 mm

■ 10 pcs./box

# DISPOSABLES

## DISPOSABLE LAPAROSCOPIC INSTRUMENTS

### Products

### Order-No.

### Description



L 18 DB-1-330/2

#### Dissecting and Grasping Forceps

- Double action
- With ratchet
- Working length: 330 mm

■ 10 pcs./box

## DISPOSABLE ELECTROSURGICAL PENCIL

### Products

### Order-No.

### Description



PD 513

PD 513 P5

#### Push Button Pencil

- W/stamping blade
- Cable length: 3 m
- Cable length: 5 m

#### For all Electrodes:

■ 10 pcs./box

# DISPOSABLES

## DISPOSABLE OVERMOULD ELECTRODE

**Products**

**Order-No.**

**Description**



**EB 22 M2**

**Standard Blade**

- Overmould
- Working length: 69 mm

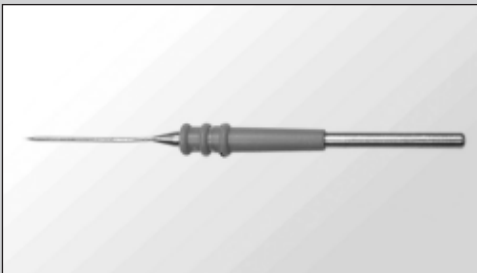

**EN 22 M2**

**Standard Needle**

- Overmould
- Working length: 69 mm

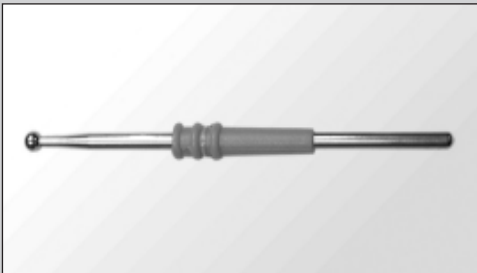

**ES 22 M3**

**Standard 3 mm Ball**

- Overmould
- Working length: 69 mm

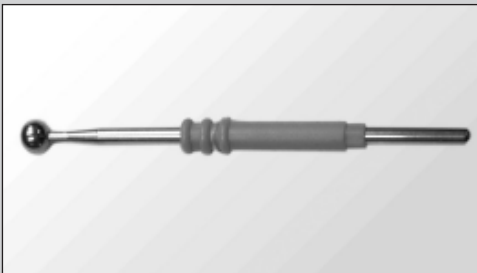

**ES 22 M4**

**Standard 5 mm Ball**

- Overmould
- Working length: 71 mm

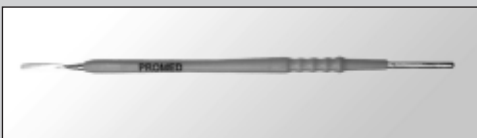

**EB 26 M2**

**Extended Blade**

- Overmould



**EN 26 M2**

**Extended Needle**

- Overmould

# DISPOSABLES

## DISPOSABLE SKIN STAPLER & REMOVER

**Inserts**

**Order-No.**

**Description**



**SP 35 R1**

**Disposable Skin Stapler**

■ Regular type

■ 6 pcs./box



**SP 35 W1**

**Disposable Skin Stapler**

■ Regular type

■ 6 pcs./box



**SR 00 D1**

**Disposable Skin Stapler Remover**

■ 10 pcs./box

# DISPOSABLES

## GROUND PAD

### Inserts

### Order-No.

### Description

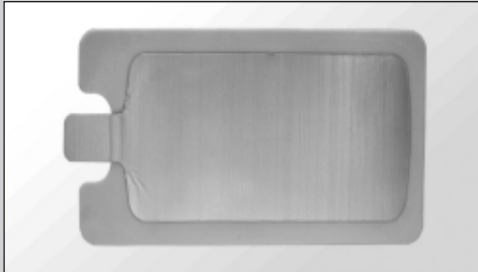

**GM 100**

**Pediatric Monopolar**

- Vertical
- Non split surface
- Conductive area: 75 cm<sup>2</sup>

■ 25 pcs./box

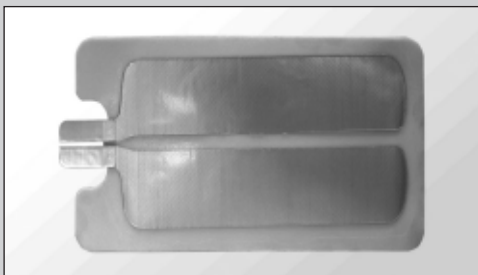

**GB 100**

**Pediatric Bipolar**

- Vertical
- Split surface
- Conductive area: 66 cm<sup>2</sup>

■ 25 pcs./box

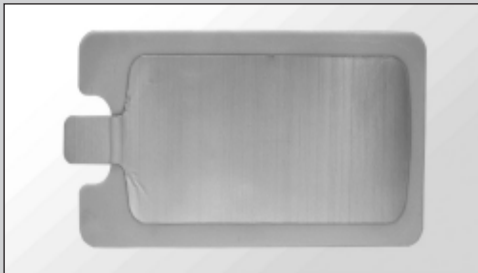

**GM 900**

**Adult Monopolar**

- Vertical
- Adult, non split surface
- Conductive area: 132 cm<sup>2</sup>

■ 25 pcs./box

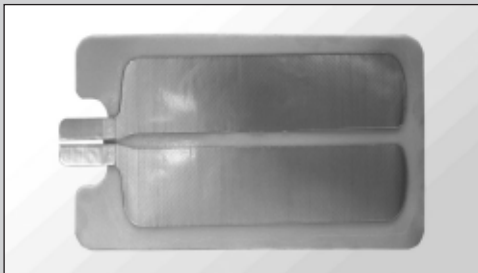

**GB 900**

**Adult Bipolar**

- Vertical
- Adult, split surface
- Conductive area: 119 cm<sup>2</sup>

■ 25 pcs./box

# DISPOSABLES

## DETACHABLE GROUND PAD CABLES

### Products

### Order-No.

### Description



**GC 2VN**

#### ValleyLab Non-Rem Type

- Cable length: 3m
- Plug type: ValleyLab non-rem plug
- Safety lock system
- PE Bag and Label

■ 50 pcs./box



**GC 2VR**

#### ValleyLab Rem Type

- Cable length: 3m
- Plug type: ValleyLab rem plug
- Safety lock system
- PE Bag and Label

■ 50 pcs./box



**GC 2HF6**

#### 6.3 mm Hi-Fi Plug

- Cable length: 3m
- Plug type: 6.3 mm Hi-Fi plug
- Safety lock system
- PE Bag and Label

■ 50 pcs./box



**GC 2HF5**

#### 5.3 mm Hi-Fi-Plug

- Cable length: 3m
- Plug type: 5.3 mm Hi-Fi plug
- Safety lock system
- PE Bag and Label

■ 50 pcs./box

**MGB**



**PROMED**  
PROMED Supply Co., Ltd.  
European Representative

MGB Endoskopische Geräte GmbH Berlin

Schwarzschildstraße 6 · 12489 Berlin, Germany

Phone: +49-30-63 92-70 10/-7000 · Fax: +49-30-63 92-70 11

E-mail: sales@mgb-berlin.de · Internet: www.mgb-berlin.de